

Good Audio is an Art



Avda. Arraona, 85 Nave 2 / 08210 Barberà del Vallès - Barcelona
+34 935 448 691 comercial@soundlightspain.com - www.soundlightspain.com

FUNKTION-ONE®



Evolution Series



The Ultimate Point Source System

Evolution is a series of versatile, high intensity, point source loudspeakers featuring Funktion-One's latest driver and waveguide developments. The Evo Series includes installation and tour ready options as well as complementary mid-high and mid-bass enclosures. This ensures Evo systems are both flexible and scalable. Evo systems are capable of very high SPL without stress or distortion, making them extremely faithful to the original audio source.

Evo loudspeakers deliver high output with excellent directivity. Their outstanding efficiency means a relatively small amount of energy and fewer enclosures are required to produce effortless clarity and openness of sound. At this level of realism, the wonderful qualities of consciousness engagement and dimension emerge.

Performance

All Evo Series loudspeakers share highly developed horn loaded Neodymium drivers designed to be naturally flat without the need for corrective EQ. The foundation of the system is an ultra low distortion 10" midrange paper cone driver. This spans over four octaves of the vocal range, from 200Hz to 4kHz with a sensitivity of 108dB/1W/1m and total harmonic distortion (THD) of less than 2% (AES2-2012). A specially modified 1.4" exit compression driver is dedicated to high frequencies only, further reducing distortion. Mid-bass is provided by a highly dynamic 4" coil 15" driver with Funktion-One high efficiency horn loading. These three horn loaded components add up to an incredibly high output enclosure, with even dynamics right down to 70Hz.

Conventional Loudspeaker

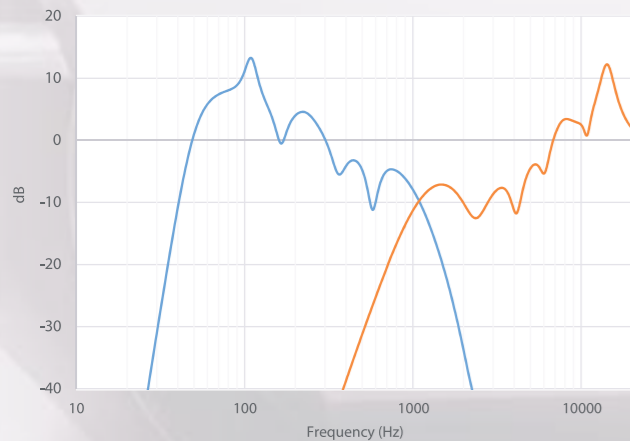

In conventional PA loudspeakers, compression drivers are paired with direct radiating cone drivers, crossed over at 1-2 kHz. The low crossover point creates distortion in the compression driver. Furthermore substantial equalisation is used to obtain a flat response, reducing headroom.

Funktion-One Evo 6/7

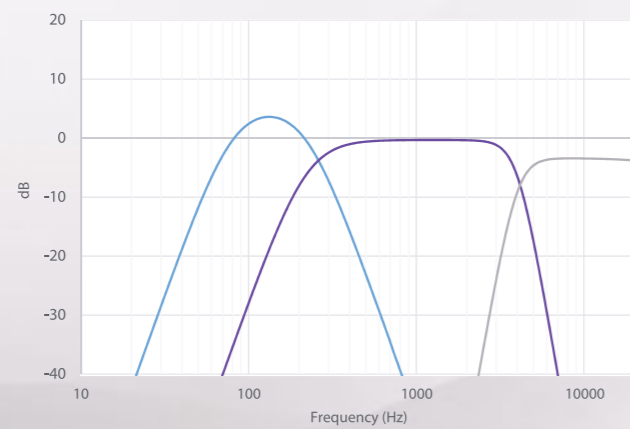

The Funktion-One approach is to use a dedicated wide bandwidth midrange. This reduces distortion and improves audio quality by moving crossover points outside the vocal range, allowing optimised mid-bass driver parameters and high frequency drivers to be transparent.

Midrange THD

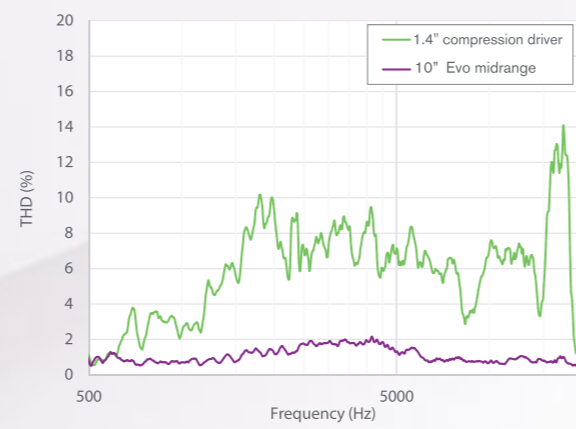

Compression drivers can produce as much as 10% THD in the midrange. Comparatively, the THD of the Evo 10" is substantially less than 2% throughout most of its range.

Evo's large waveguides confer excellent directivity down to low-mid frequencies, enabling sound to be focused on audience areas and minimising reflections from venue surfaces. In a festival environment it means reduced offsite noise. In a nightclub it means high intensity sound on the dance floor and low sound levels at the bar.

This level of control in both horizontal and vertical planes is only possible with a modular point source system. Evo systems can be finely tailored to the coverage requirements of each event or installation.

A full range of accessories is available for quick and safe deployment in a range of environments. The Evo 7T (Touring) enclosures have integrated metalwork for simplified stacking and flying. All Evo enclosures are made from birch plywood and are available in a variety of finishes, including a highly durable and weather resistant black polyurea coating or classic Funktion-One violet. Wheel boards provide protection and ease of transportation. Foam lined grilles are available for the full Evolution Series for a discreet appearance if needed.



Foam lined steel grilles for discreet appearance



Optional wheelboards for ease of transport

Two Directivity Options

EVO
6
50°

Evo 6 enclosures have a horizontal dispersion of 50°. A trapezoid enclosure provides the optimal inter-cabinet array angle of 40°. A two wide array gives 100° of smooth coverage.



EVO
7
35°

Evo 7 enclosures have a narrower horizontal dispersion of 35° for increased intensity and projection. The Evo 7 has the correct trapezoid enclosure angle for optimal horizontal summation at 30°. A two wide array gives 75° of smooth coverage.

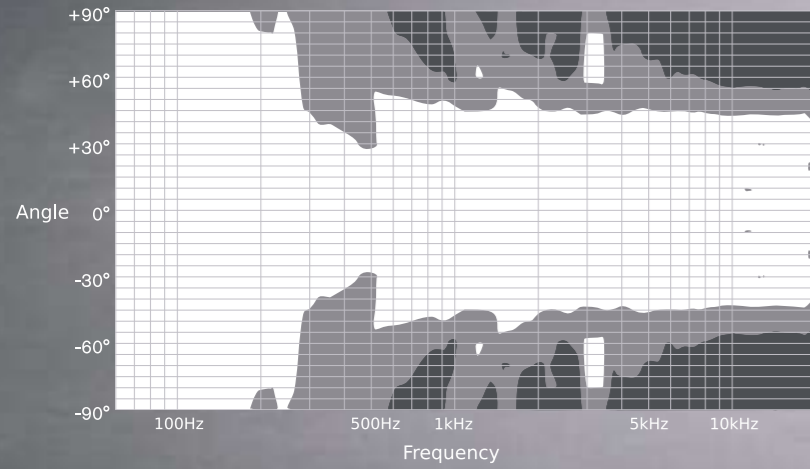
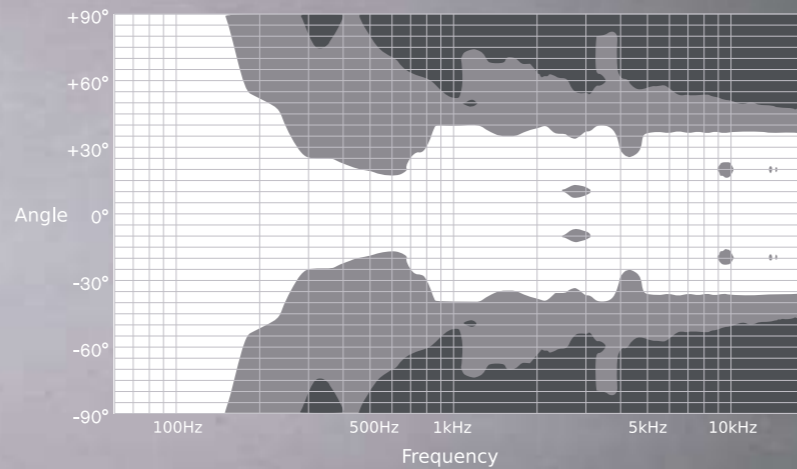

Precise design ensures fidelity is achieved without resorting to corrective EQ, maximising dynamic headroom



Evo 6E



Evo 6EH



Evo 6SH



Evo 6EL

Evo 6's wider coverage is suited to smaller events where only one or two cabinets are required per side. It is popular as a four point club install or as a compact system for live venues.

EVO 6

EVO 6 Range



Evo 6E

Evo 6E is a high intensity, three way loudspeaker. It combines a Funktion-One signature 10" midrange with a horn loaded 15" mid-bass and a 1.4" compression driver in a compact cabinet. This results in class leading efficiency and performance. The Evo 6E is also available with passive high frequency crossover, giving the option of two way amplification.

- Fully horn loaded three way cabinet
- Fitted with MIO flypoints
- Funktion-One designed neodymium drivers
- 70Hz - 18kHz frequency response
- 57kg weight
- 50° horizontal x 25° vertical dispersion
- Various coatings and colour options
- 2 x Speakon NL8 connectors

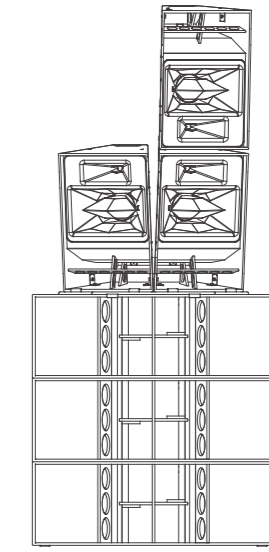
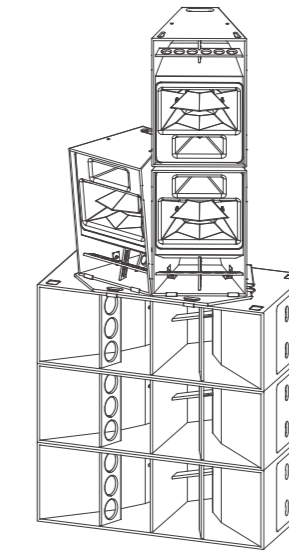
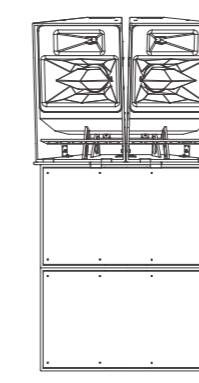
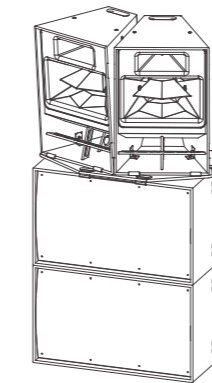

Evo 6E x 2 + BR221 Bass x 2 (per side)
System capability: 15W x 15L metres

Evo 6E x 3 + F221 Bass x 3 (per side)
System capability: 15W x 20L metres



Evo 6EH / 6SH

The Evo 6EH is the mid-high section of an Evo 6E, housed in a plywood cabinet. The Evo 6SH is the waveguide only version of the same loudspeaker, ideal for applications where a lower weight or profile is required. It comes complete with a yoke for pan and tilt. A passive high frequency crossover option is also available.

Both the Evo 6EH and 6SH can be used in a wide range of applications, such as combining with F215 or F315 mid-bass and BR or F-Series bass to form a complete system for music. They can also be used to provide additional vertical coverage or to reinforce the mid-high section for extended reach of an Evo 6E system. The wide bandwidth of the Evo 6EH and 6SH enables standalone use for speech applications.

- Fully horn loaded two way cabinet
- Fitted with M10 flypoints (EH)
- Fitted with rotatable yoke (SH)
- Funktion-One designed neodymium drivers
- 200Hz - 18kHz frequency response
- 38kg (EH) / 20kg (SH) weight
- 50° horizontal x 25° vertical dispersion
- Various coatings and colour options
- 2 x Speakon NL4 connectors

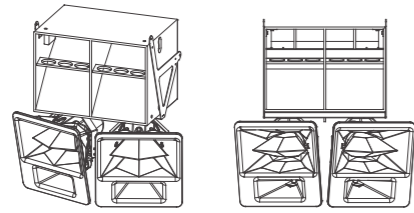

Evo 6SH x 2 + F215 Mid Bass x1 (per side)
System capability: 15W x 15L metres

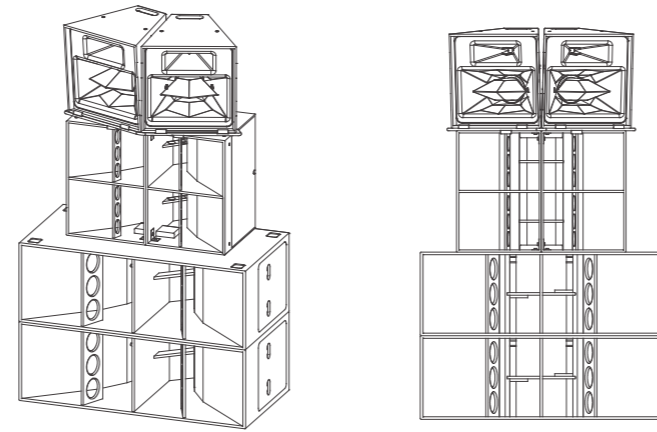

Evo 6EH x 2 + F215 Mid Bass x 2 + F221 Bass x 2 (per side)
System capability: 15W x 15L metres



Evo 6EL

The Evo 6EL-115 is a single 15" enclosure that doubles the mid-bass capacity of the Evo 6E, useful when using only one Evo 6E per side. With identical footprint and driver loading, it can be bolted directly to other Evo 6 cabinets. Also suitable for use with the Evo 6EH and 6SH.

- Fully horn loaded one way cabinet
- Fitted with M10 flypoints
- Funktion-One designed neodymium driver
- 70Hz - 250Hz frequency response
- 30kg Weight
- Various coatings and colour options
- 2 x Speakon NL4 connectors



Evo 6EH + 6EL

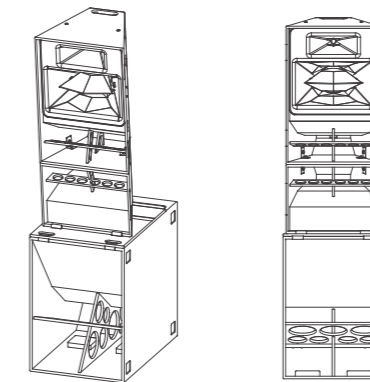

Evo 6E x 1 + Evo 6EL x 1 + F124 Bass x 1 (per side)
System capability: 10W x 15L metres



Evo 6E + 6EL



Excellent directivity ensures sound is focused on audience areas, minimising reflections and off-site noise



Evo 7E



Evo 7EH



Evo 7SH

Evo 7's more focused waveguide (35° nominal horizontal dispersion) increases intensity and projection, naturally suiting it to larger scale events. An additional row of enclosures enables an increase in directivity or a mirrored Evo 7EH above can be used to increase throw.

EVO 7 Range

Evo 7E

Evo 7E is a very high intensity, three way loudspeaker. It combines a Funktion-One signature 10" midrange with a horn loaded 15" mid-bass and a 1.4" compression driver in a compact cabinet. This results in class leading efficiency and performance. The Evo 7E is also available with a passive high frequency crossover, giving the option of two way amplification.

- Fully horn loaded three way cabinet
- Fitted with MIO flypoints
- Funktion-One designed neodymium drivers
- 70Hz - 18kHz frequency response
- 61kg weight
- 35° horizontal x 20° vertical dispersion
- Various coatings and colour options
- 2 x Speakon NL8 connectors

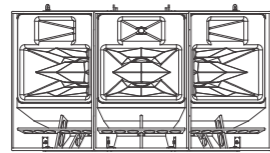
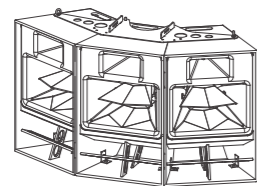

Evo 7E x 3 (per side)
System capability: 20W x 20L metres

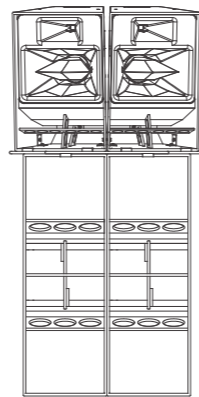
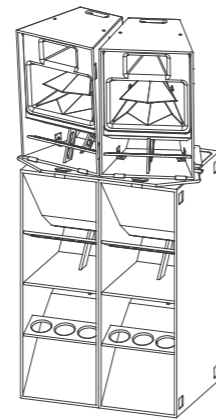

Evo 7E x 2 + F221 Bass x 2 (per side)
System capability: 15W x 20L metres

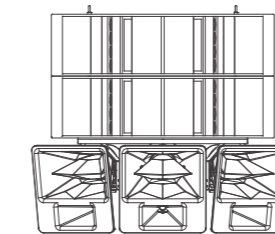
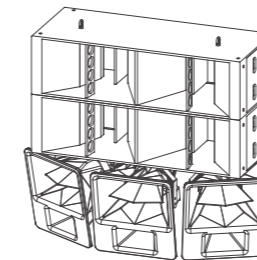

Evo 7SH x 3 + F315 Mid-Bass x 2 (per side)
System capability: 20W x 20L metres

Evo 7EH / 7SH

The Evo 7EH is the mid-high section of an Evo 7E, housed in a plywood cabinet. The Evo 7SH is the waveguide only version of the same speaker, without the plywood enclosure, for applications where a low weight solution or lower profile is required. It comes with a yoke for pan and tilt.

Both the 7EH and 7SH can be used in a wide range of applications, such as combining with F215 or F315 mid-bass and BR or F-Series bass to form a complete system. They can also be used to provide additional coverage for an Evo 7E system, or to reinforce the mid-high section for extended reach. Both 7EH and 7SH are optionally available with passive high frequency crossover.

- Fully horn loaded two way cabinet
- Fitted with MIO flypoints (EH)
- Fitted with rotatable yoke (SH)
- Funktion-One designed neodymium drivers
- 200Hz - 18kHz frequency response
- 41kg (EH) / 23kg (SH) weight
- 35° horizontal x 20° vertical dispersion
- Various coatings and colour options
- 2 x Speakon NL4 connectors

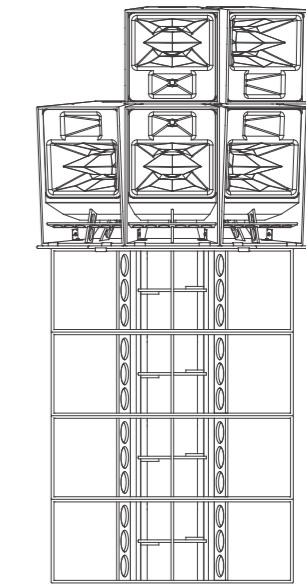
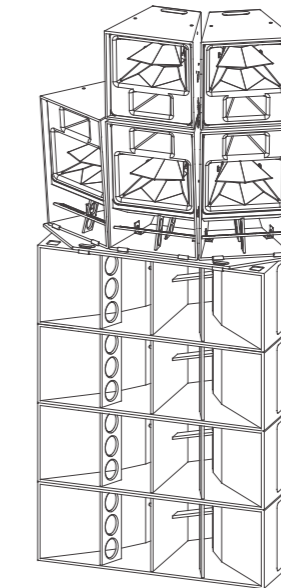

Evo 7E x 3 + Evo 7EH x 2 + F221 Bass x 4 (per side)
System capability: 20W x 30L metres



Evo 7TL



Evo 7TH



Evo 7T

The Evo Touring range features the Evo 7T, Evo 7TH and Evo 7TL-215, which all share the same footprint and integrated flying system for fast, accurate and effective rigging or ground stack deployment. The increase in scalability that comes with the addition of the Evo 7TH and Evo 7TL-215 means that Evo Touring configurations can comfortably deliver precise and even coverage to audiences of up to 10,000 people.

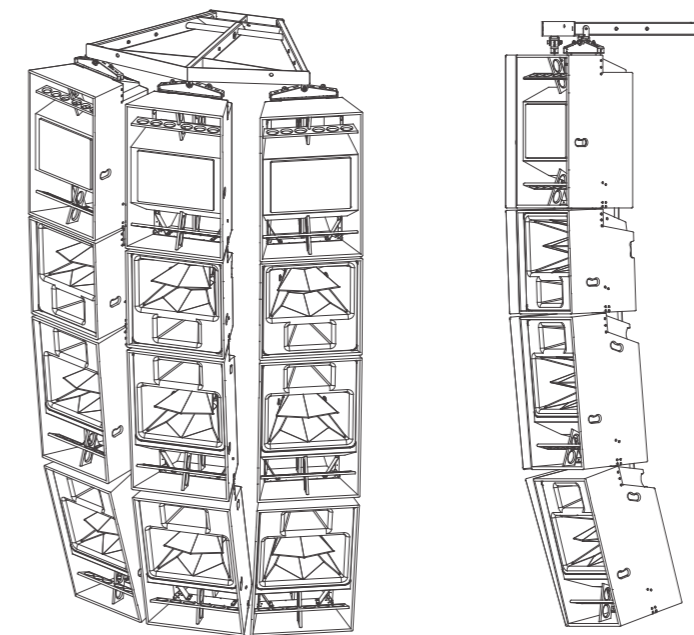

Evo 7TL x 3 + Evo 7TH x 3 Evo 7T x 6 (per side)
System capability: 40W x 50L metres

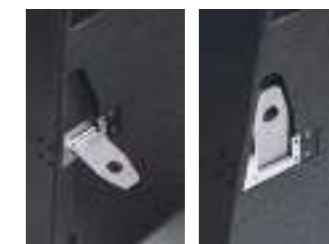

Integrated flying system for fast and accurate rigging. The system can also be used for ground stacking.

7T

EVO Touring



Evo 7T

Evo 7T is a very high intensity touring loudspeaker, which features a 10" Funktion-One signature midrange with a horn loaded 15" mid-bass and a 1.4" compression driver. It has 35° of horizontal dispersion and physically arrays at 30°. A three wide array gives smooth coverage to 100°.

- Fully horn loaded three way cabinet
- Integral flying and stacking metal work
- Funktion-One designed neodymium drivers
- 70Hz - 18kHz frequency response
- 70kg weight
- 35° horizontal x 20° vertical dispersion
- Various coatings and colour options
- 2 x Speakon NL8 connectors

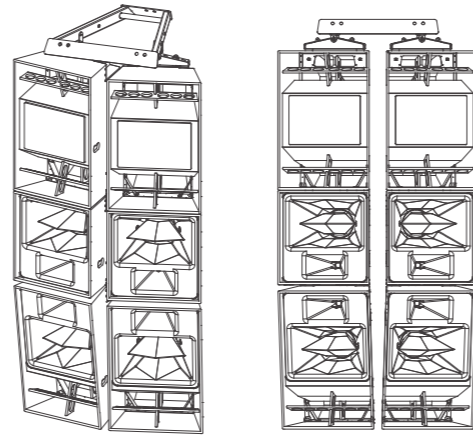

Evo 7TH x 2 + Evo 7TL x 2 + Evo 7T x 2 (per side)
System capability: 20W x 30L metres



Evo 7TH

Evo 7TH is the mid-high section of the Evo 7T. It features Funktion-One 10" midrange and a 1.4" compression driver for high frequencies. It is significantly smaller than the Evo 7T, making it extremely flexible and adaptable to a number of configurations. The Evo 7TH has an inverted waveguide, allowing the high and mid frequencies to mirror perfectly with those of an Evo 7T flown underneath. This enables mutual reinforcement in the far field for increased reach and audience capacity.

- Fully horn loaded two way cabinet
- Integral flying and stacking metal work
- Funktion-One designed neodymium drivers
- 200Hz - 18kHz frequency response
- 44kg weight
- 35° horizontal x 20° vertical dispersion
- Various coatings and colour options
- 2 x Speakon NL8 connectors

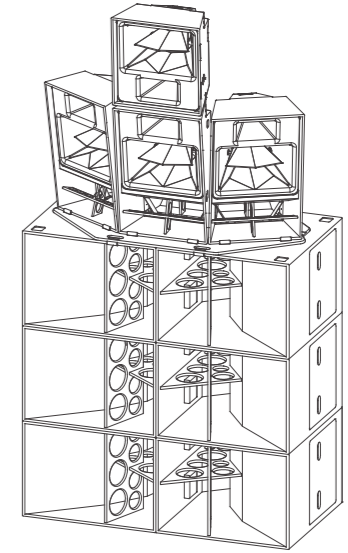

Evo 7TH x 1 + Evo 7T x 3
+ F124 Bass x 6 (per side)
System capability: 25W x 30L metres



Evo 7TL

Evo 7TL-215 features two horn loaded 15" drivers in an enclosure that is identical to the Evo 7T, providing mid-bass reinforcement for flown and ground stacked Evo 7 configurations. It can also be paired with an Evo 7TH as a standalone combination, maximising application and scalability.

- Fully horn loaded one way cabinet
- Integral flying and stacking metal work
- Funktion-One designed neodymium drivers
- 70Hz - 250Hz frequency response
- 61kg weight
- Various coatings and colour options
- 2 x Speakon NL8 connectors

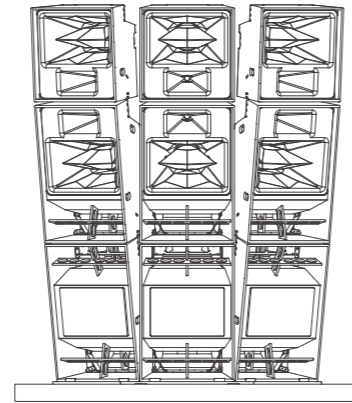
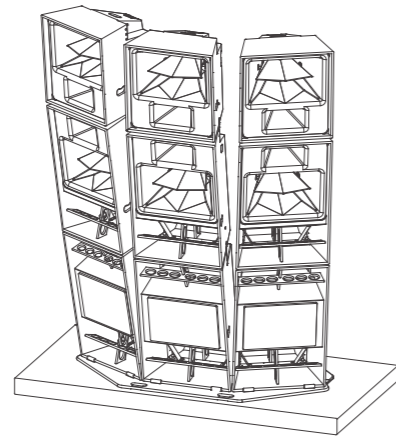

Evo 7TL x 3 + Evo 7TH x 3 + Evo 7T x 3 (per side)
System capability: 25W x 30L metres

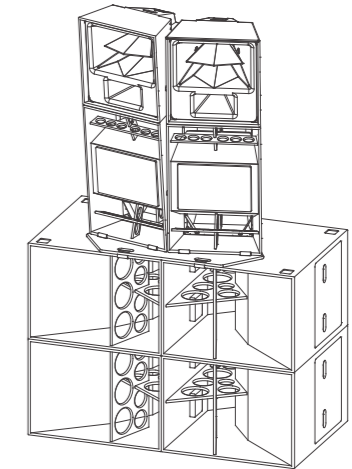

Evo 7TH x 2 + Evo 7TL x 2
+ F124 Bass x 4 (per side)
System capability: 15W x 20L metres

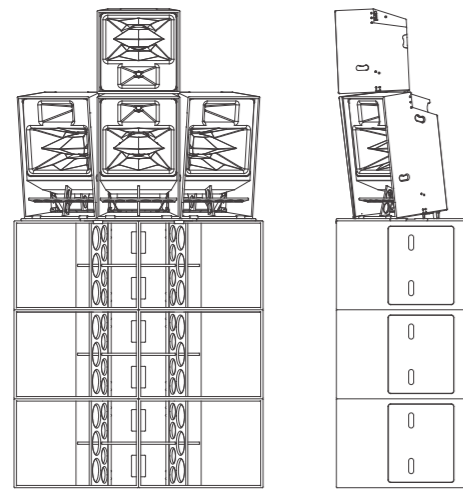

Ground Stack System

Funktion-One's Ground Stack system provides a safe, precise and convenient method for stacking all Evolution enclosures on Funktion-One bass cabinets. Alternatively, the Ground Stack system can be used on dedicated platforms, allowing the optimum implementation of a mono bass stack. The integrated metalwork in the Touring cabinets allows a second and third row of cabinets to be stacked with no additional components needed.

Flying System

The patented Evolution Flying System is both simple and safe. The proven design enables the fast and precise implementation of a point source array. Two wide and three wide flying grids are capable of hanging four cabinets deep per column.

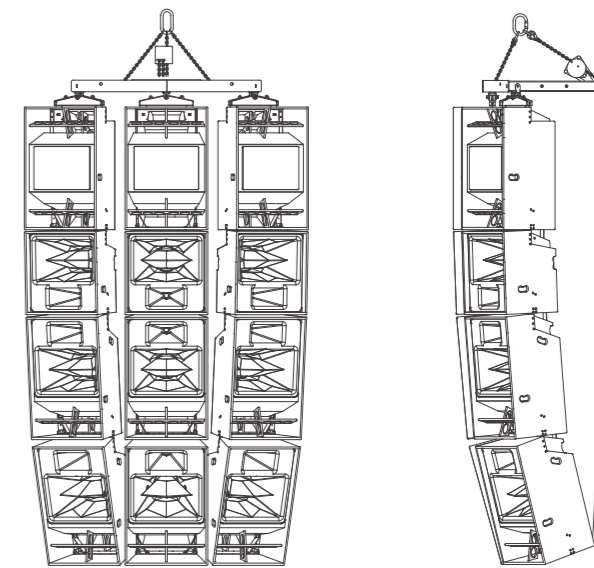



BASS

Range

Bass Enclosures

Evo loudspeakers can be partnered with either the F-Series horn loaded bass enclosures or the BR Range bass reflex enclosures.

The F-Series bass options are recommended for all sizes of venue, especially large outdoor environments, while the BR Range's softer listening character is better suited to more intimate venues.

The F132 and BR132 can extend the performance of an Evo system down to infrabass frequencies.



BR132



F124



BR221



F221



F215



BR121



Evo Stadium Sound Design



Directivity

Stadia are extremely challenging acoustic environments, with different specifications for sport and music. Strong directivity control is essential to maintain a high direct to reverberant ratio and to meet intelligibility requirements. The large waveguides of the Evo 6SH and Evo 7SH control directivity down to low mid frequencies. Furthermore, the acoustic design of the individual waveguides allows assembly into precise and seamless arrays. The Evo 6 and Evo 7 have nominal horizontal dispersions of 50° and 35° respectively, in contrast to most line array systems which have very wide horizontal dispersions of 90° to 120°. The narrower directivity of the Evos means sound is more focused on audience areas, reducing unwanted reflections and excitation of the reverberant field.

Another advantage of Evo systems is their high degree of modularity. By separating frequency bands into individual components, bespoke system designs and arrays can be realised to produce a consistency of coverage not possible with 'one box' systems.



Intelligibility

Vocal clarity and realism are at the heart of our design philosophy. We spend our lives listening to real acoustic speech so we are, therefore, very sensitive to distortion of the human voice. With our advanced transducer and waveguide designs, we have extended the midrange bandwidth to cover 200Hz to 4kHz and have reduced harmonic distortion to less than 2% at over 126dB (Evo 7). In moving the crossover points outside the voice range and using very low distortion transducers, we achieve exceptional clarity, intelligibility and dynamic range.

Efficiency

Sustainability and reducing CO2 emissions are key concerns for the modern stadium. Loudspeakers are extraordinarily inefficient transducers - a typical stadium PA consumes tens to hundreds of kilowatts of electricity to produce just a few watts of sound power.

Funktion-One has a long history of research into improving loudspeaker efficiency, originally in response to the limitations of early power amplifiers which rarely delivered more than 100W into 8 ohms. The development of high fidelity, high power PWM amplifiers in the 2000s revolutionised the sound reinforcement industry. Rather than using high power amplifiers to enable low efficiency loudspeaker design, we have combined the high electrical efficiency with high acoustic efficiency. This directly results in a requirement for fewer loudspeakers and amplifiers and consequently reduced CO2 emissions.

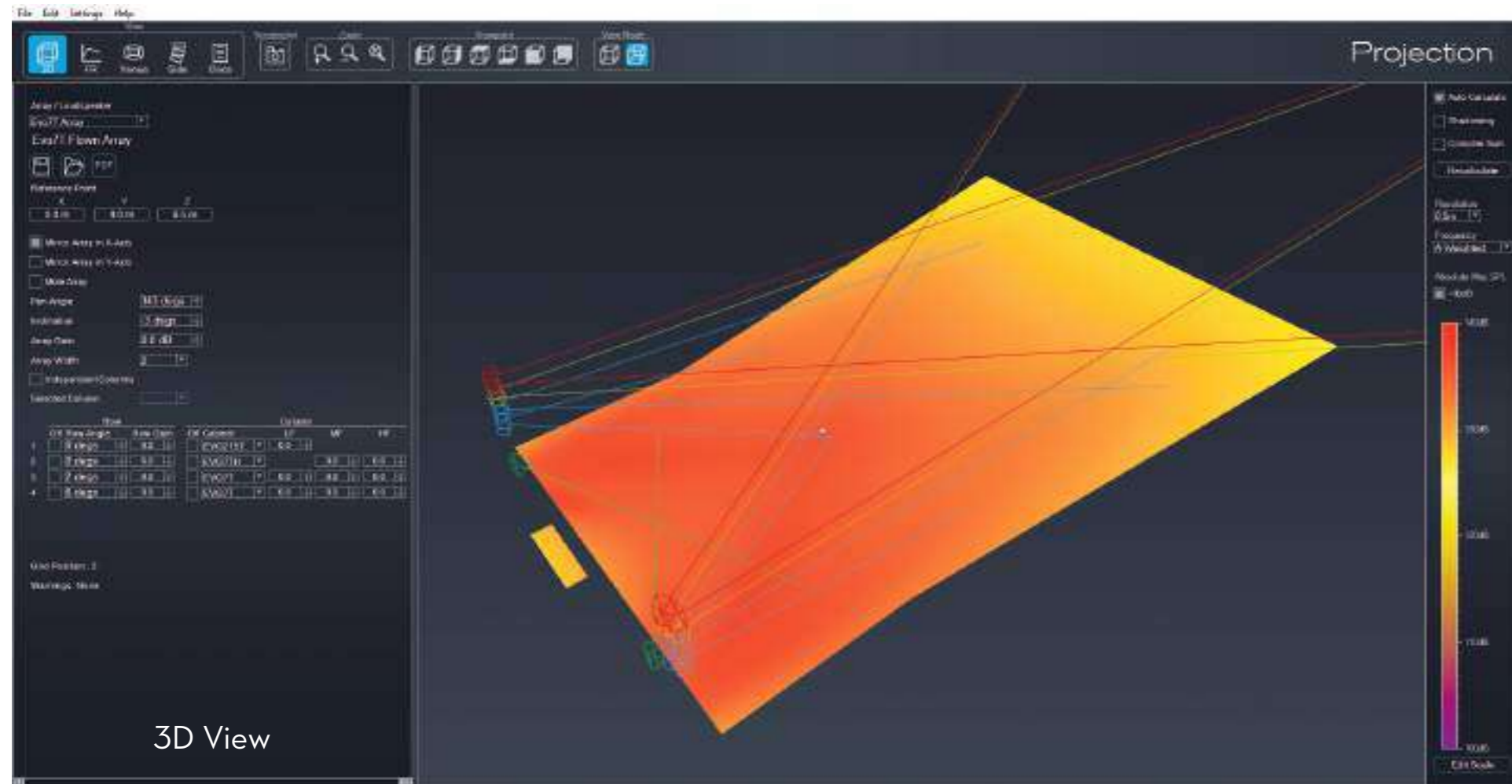

3D View

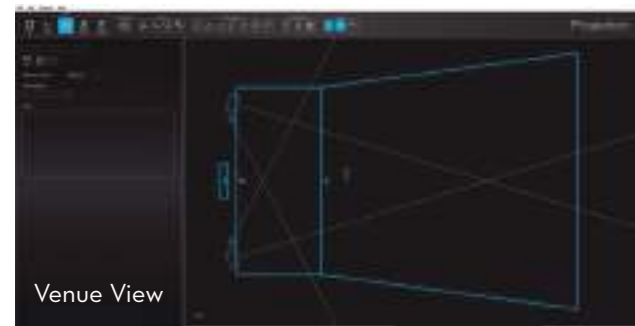

Venue View

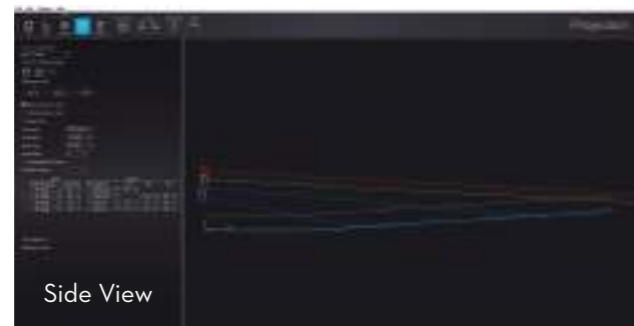

Side View

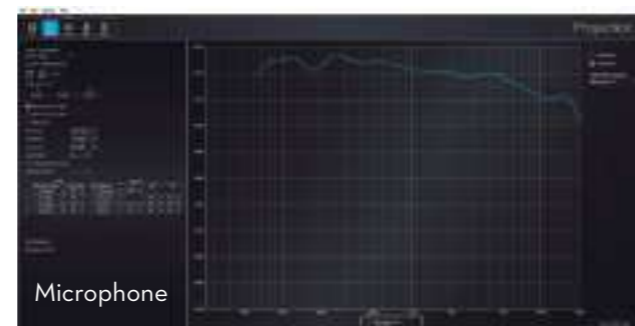

Microphone

Evo Projection Software

Projection software enables users to optimise Evo configurations for a range of installation and live event environments

Projection is a program for fast venue modelling and system design. The program has been developed in-house by Funktion-One for the Windows platform. Software updates regularly add new functionality.

Venue View

Building venue models in Projection is fast and easy. Simple geometric shapes can be combined to build a complex 3D model of a venue. Shadowing from walls can be included in the calculation.

Side (Array) View

Arrays are designed and aimed in the side view, setting trim height, cabinet types and angles. Row and band gains can be adjusted to optimise performance. The required positions on the grid are displayed along with the total load.

3D View

The resulting sound field is calculated in three dimensions with the levels plotted on intersecting horizontal or vertical planes.

The calculation algorithm is very efficient, with results for most venue sizes available in seconds, rather than minutes. This enables near real time system design and optimisation.

Two acoustic summation algorithms are available; a magnitude calculation for mid-high frequencies and optionally a complex calculation (including phase) for viewing low frequency interaction between loudspeakers.

Microphone Function

Virtual microphones can be added to the venue model to view the frequency response of the system at any position within the model. Responses can be A-weighted or unweighted.

Amplification

Evo systems are powered by the Funktion-One D-Series or F-Series amplifiers. Both D and F-Series consist of four channel amplifiers, plus additional high power two channel amplifiers (D120 and F100-2).

All four channel amplifiers are optionally available with integrated DSP. The D-Series has optional Dante connectivity (including non-DSP models).



Model	Channels	Power (4 Ω)	DSP Option	Dante Option
D40	4	4 x 1000W	Yes	Yes
D80	4	4 x 2000W	Yes	Yes
D100	4	4 x 2700W	Yes	Yes
D120	2	2 x 4600W	No	Yes
F20Q	4	4 x 500W	Yes	No
F40Q	4	4 x 1000W	Yes	No
F60Q	4	4 x 1500W	Yes	No
F80Q	4	4 x 2000W	Yes	No
F100-2	2	2 x 3000W	No	No

Research & Development

Our R&D team has a long history of innovation, being responsible for a number of industry firsts, including the turnkey package touring system, the 21" loudspeaker frame size and the integrated loudspeaker management system.

Furthermore, we were early adopters of live spatial audio technology, computer based electroacoustic measurement systems, composite cabinet and diaphragm materials, Neodymium magnets and PWM (Class D) amplification.

All critical design decisions at Funktion-One are informed by comprehensive listening tests. The results of these tests are validated by in-depth electroacoustic measurements with both industry-standard and bespoke instrumentation and software.

We have also designed and constructed a robot for automated 3D directivity measurement of loudspeakers and arrays weighing over 300kg. We have also developed a range of new measurement types and methods in our pursuit of audio excellence.



EVO Dimensions

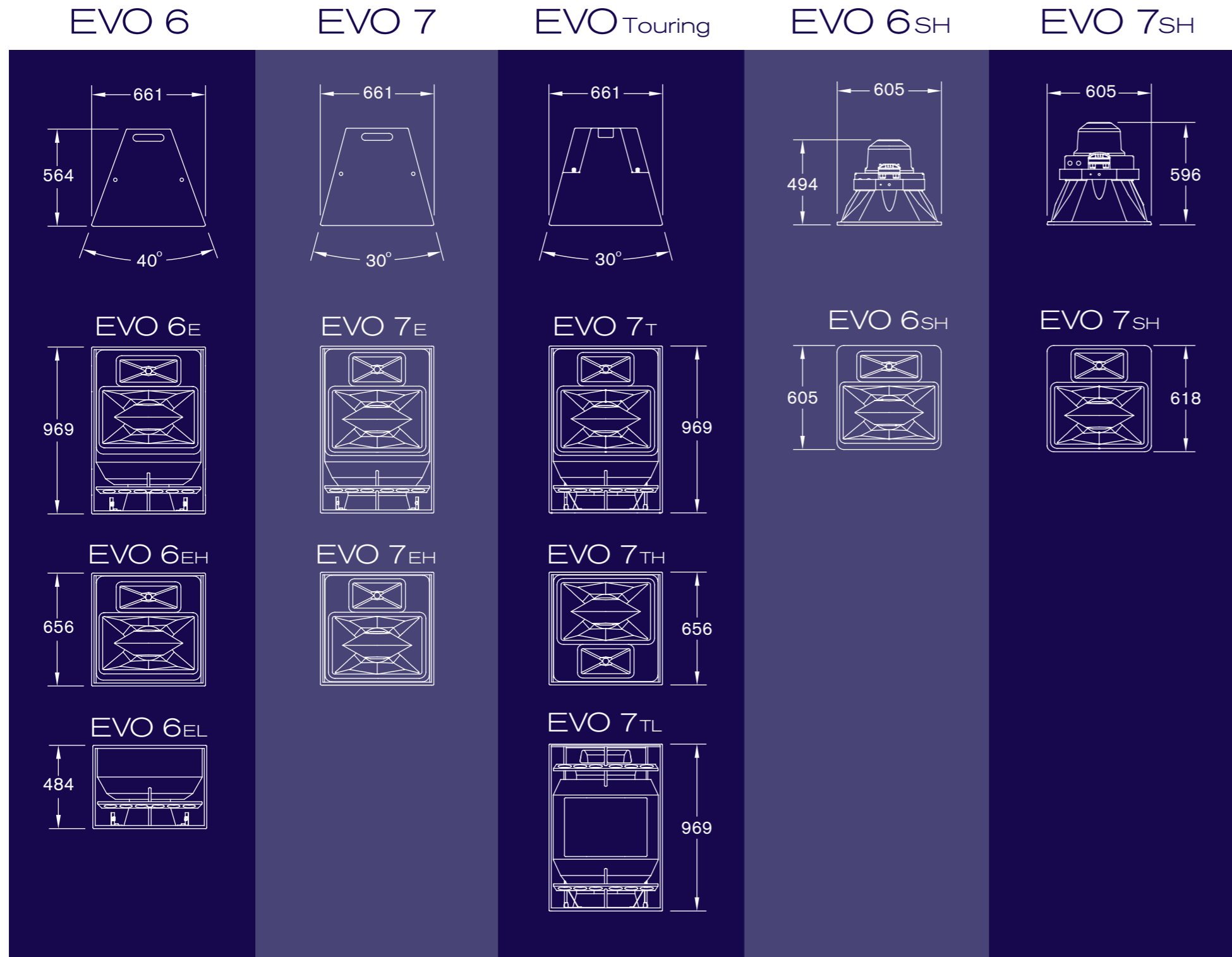

The Ultimate Point Source System

Evo
Series

www.soundlightspain.com